

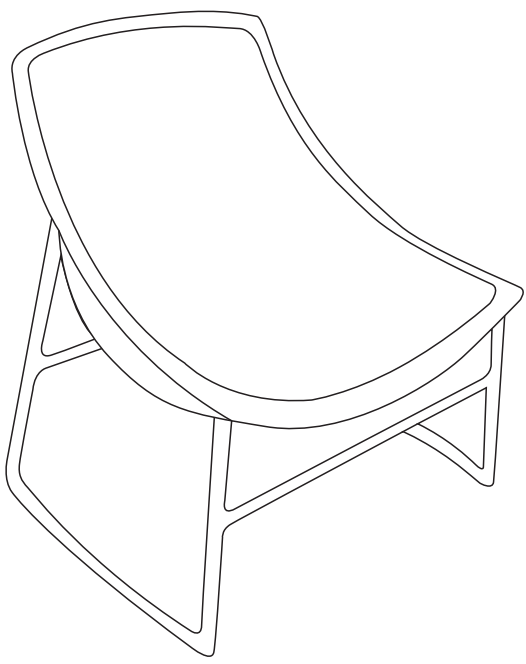

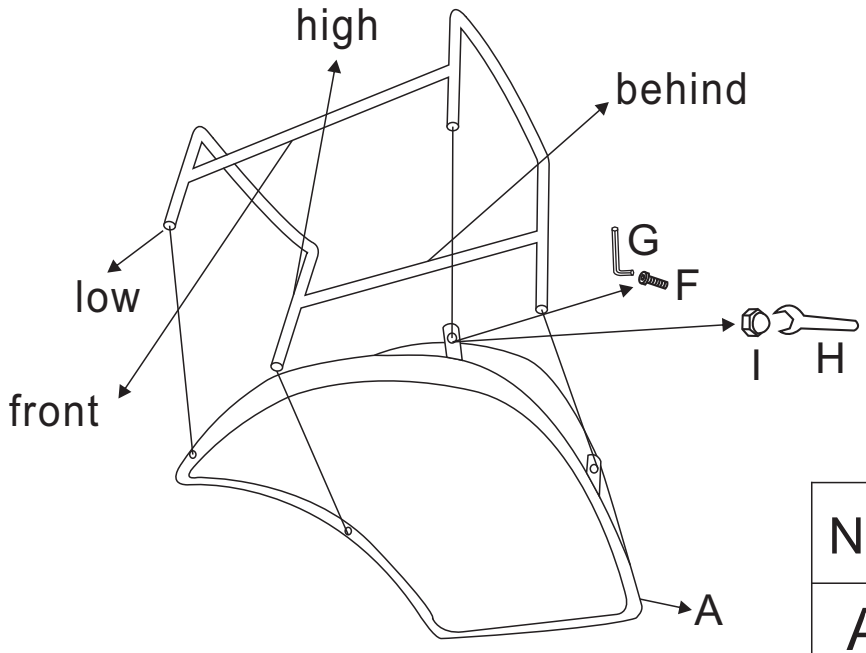

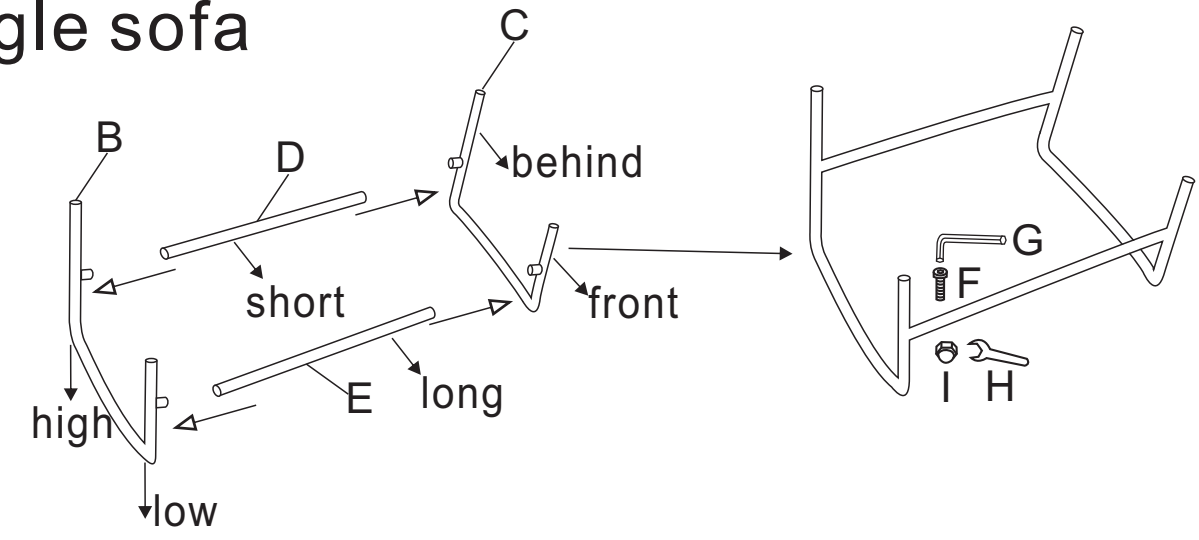



Single sofa

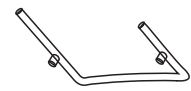







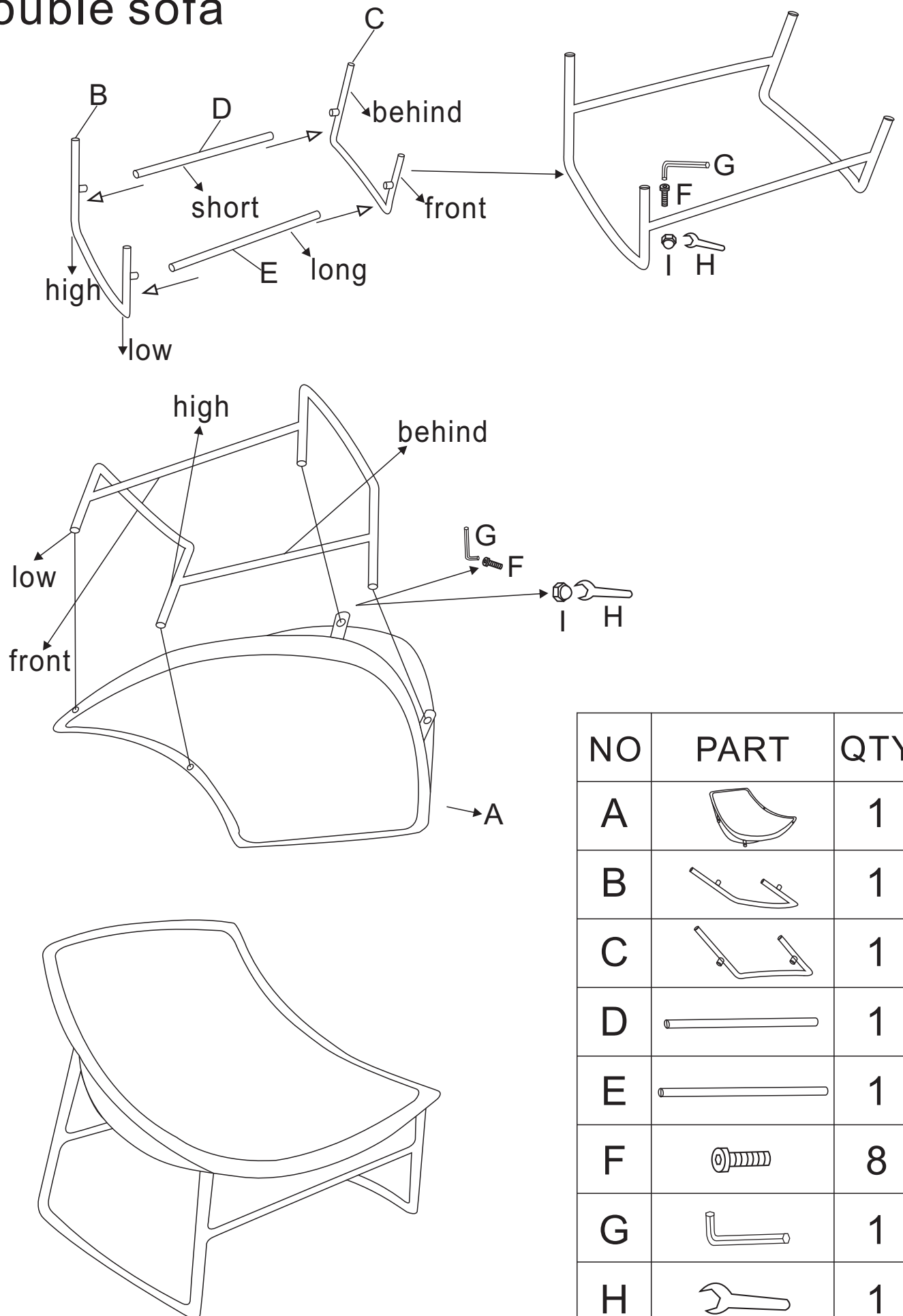

NO	PART	QTY
A		1
B		1
C		1
D		1
E		1
F		8
G		1
H		1
I		8

If you find the screw drill hole can not be totally fit, you can try to clap the tube with hands

Double sofa

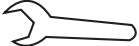





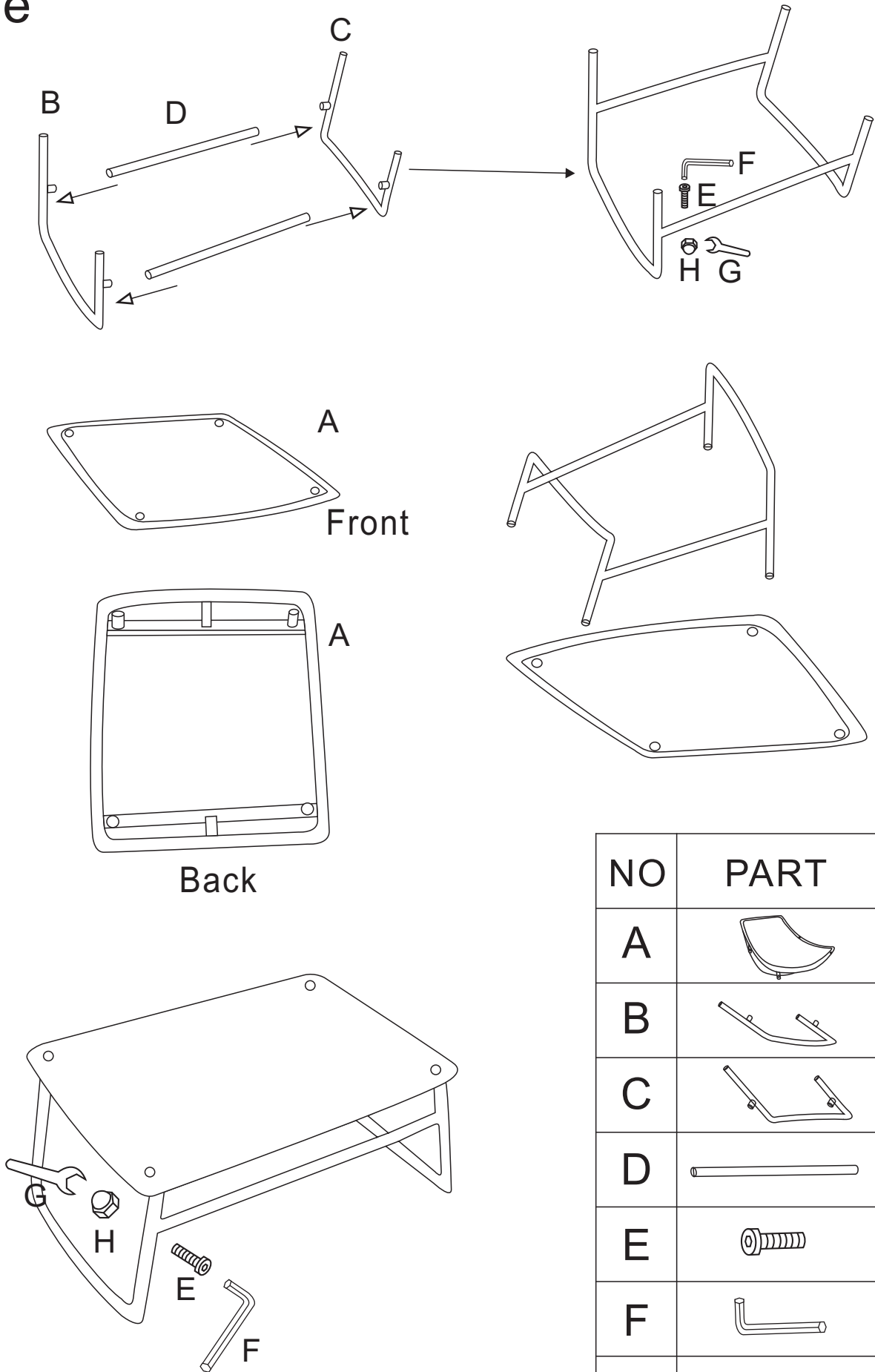

NO	PART	QTY
A		1
B		1
C		1
D		1
E		1
F		8
G		1
H		1
I		8

If you find the screw drill hole can not be totally fit, you can try to clap the tube with hands

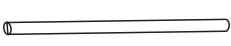
Table



NO	PART	QTY
A		1
B		1
C		1
D		1
E		1
F		8
G		1
H		1

If you find the screw drill hole can not be totally fit, you can try to clap the tube with hands